

St. James's

EPISCOPAL CHURCH
West Hartford Center

November 2014

From the Rector's Study

"Money Matters"

Yes, it's that time of year again

THE Episcopal Church defines membership using three criteria. These criteria are: (1) regular participation in the Eucharist in public worship, (2) involvement in the wider life and ministries of the parish and (3) regular and faithful giving to the financial health and operation of the parish. This third criterion does not mean dropping a few dollars in the plate every now and then, but the prayerful and generous filling out of a pledge card and the faithful attention to the fulfillment of that financial pledge.

While everyone has different abilities to meet these membership criteria, it is the intentionality and prayerful way in which you try that matters. The Episcopal Church has never had a set of beliefs that we use as a litmus test for membership—"a confessional church." We are a "communion"—we base membership on participation in the faithful gathering of the parish in our participation in God's mission and ministry.

Every year in the fall, churches and other faith communities around the country directly address the issues around the financial realities of their operating budgets and the successful continuation of their current ministries as well as the ever-changing needs of their communities. There are as many ways to do this as there are parishes—some low key, some very aggressive, and some biblically/theologically based, while others might be based solely on the line items of the budget itself. Here at St. James's we are no different; we have expenses related to our participation in God's mission and ministry that need to be addressed. We do try to keep our annual stewardship program somewhat low key, providing each household with the financial facts of parish life while at the same time encouraging folks to come to a fuller understanding of God's generosity and abundance. As people of faith we are called to find the theologically and spiritually healthy and appropriate ways of responding.

No one likes to talk about money in the context of something so personal and intimate as our relationship with God and each other. I don't like to ask any more than you like to be asked. But here are the nuts and bolts of it. In 2014 St. James's had a budget of \$764,300.00 of which \$543,700.00 came from pledges and \$17,700.00 came from other donations. The remaining income of \$202,900.00 came from endowment and building income. That means that nearly 75% of our operating budget came from you.

Thank You.

Another reality is that we can't rely on a small percentage of the congregation to meet our financial needs. But for theological, spiritual, and moral needs we need everyone to participate—that's what it means to be a member, and that's what it means to be a faithful Episcopalian.

Faithfully,

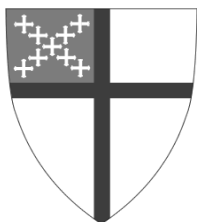

To Learn, Live and Teach the Values of
the Gospel of Jesus Christ

Treasurer's Report

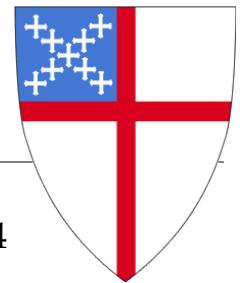

St. James's Treasury Report Reported Results Year to Date through September 2014

Current Position: The church finances in the month of September seem to be following the changing weather of the fall season. After reporting an overall \$5,400 positive variance to the budget as of the end of August, the church is now in a \$6,251 shortfall relative to budget. The primary reason for the \$11,650 change during the month is due to a large decrease in pledges relative to budget during the month. At the end of August, pledges were \$2,100 below budget; at the end of September, they are \$12,600 below budget. Most of the remaining income items changed little during the month. Expenses improved during the month as they improved from \$11,500 less than budget as of the end of August to \$12,338 less than budget at the end of September. Expenses will continue to be monitored and we'll hopefully see a rebound in pledge payments during the final few months of the year.

Income & Expense Summary:

Category	YTD Actual	YTD Budget	YTD Variance	Total Annual Budget
Income (+)	\$533,761	552,350	18,589 Below plan	764,300
Expense (-)	554,322	566,660	12,338 Below plan	764,300
<i>Net</i>	(20,561)	(14,310)	6,251 Negative variance to budget	0

Income: Year-to-date (YTD) actual income is \$18,589 below budget (or 3.4% worse than budget). As of the end of August, this figure was \$6,160 less than budget (1.2% of budget).

Expense: YTD expenses remained relatively stable during the month. As of the end of August, expenses were \$12,338 below budget; this difference represents 2.2% of the budgeted amount. Expenses were \$11,530 (or 2.3%) above budget at the end of August.

Inside this Issue	Page #
From the Rector's Study	Cover
Treasurer's Report/What's Inside	2
From the Assistant Rector	3
St. James's Center for Children	4-5
Music & Liturgy	6
Outreach	7
Around the Parish	8-10
Women of St. James's	10
November Calendar	11
Holiday Tea Flyer	Insert

Important Dates to Remember!
Saturday, November 1 - Parish Fall Auction, 7pm
Sunday, November 2 - All Saints' Sunday (one service at 10am) and Annual Stewardship Brunch
Friday, November 7 - First Friday Family Night from 5:30 to 7pm
Sunday, November 9 - Rhythms of Grace at 4pm and Youth Second Sundays at 5:30pm
Saturday, November 15 - Parish Fall Cleanup from 9:30am until finished
Wednesday, November 19 - Boys & Girls Choral Evensong in the church at 6pm
Sunday, November 23 - UTO Sunday Ingathering
Thursday, November 27 - Thanksgiving Day Holy Eucharist at 10am in the chapel
Sunday, November 30 - Intergenerational Event "Let's Stuff Stockings!" after the 9:30 service

From the Assistant Rector

Dear Sisters and Brothers,
From what I can recall, the process for Confirmation when I was an adolescent... a younger adolescent... involved a handful of classes and a big celebration after the bishop did his thing and confirmed that we had confirmed to be confirmed.

I remember one class in which we got a look behind the altar and in the sacristy to talk about how Episcopalians like to give really complicated names to really ordinary things (aspergillum is my favorite...Google it).

That's about it.

Don't get me wrong—I'm sure there was more to it, and I'm glad for having had the experience, but the impact those classes have on my day-to-day life *seem* minimal. That's because immediate takeaways are not the goal of a Confirmation program—it's not merely a time for church leaders to pass on knowledge to the new generation; if that were the case, I'd simply hand out a few books and ask the students to study.

We do strive to cover such topics as liturgy, theology, and church history in a way that is approachable and engaging, but the goal of our Confirmation program is to value the beliefs and insights of the students while facilitating a meaningful encounter for them with the richness of our tradition.

Ten fantastic high schoolers are several classes into this year's Confirmation course at St. James's. On Columbus Day Weekend, we all spent time together at Camp Washington. At the end of the first night, one of the chaperones asked me what I hoped for out of the retreat. I said that I hoped the group would become a community. Some of them had already been familiar with one another, but many of them were strangers. By the end of the weekend, everyone seemed to have a much greater sense of one another, and they had started to build a group identity.

Had I told the chaperone that my goal for the weekend was to convince all ten high schoolers that the Episcopal Church is perfect and that they'd be fools to not become life long members, I would have failed miserably and missed the point of Confirmation altogether.

Don't get me wrong, the students will hear of the richness of our tradition and learn how The Episcopal Church came to be. They'll learn about saints and heretics, about scripture and liturgy and theology, but most importantly, they'll have a plethora of opportunities to engage each other in the context of Christian community.

As Lisa Kimball of Virginia Theological Seminary and The Confirmation Project summarizes, Confirmation can be, "an opportunity for a life-shaping encounter with the church."

When I think about my Confirmation class, I don't remember much, but when I look back on my whole experience at Church of the Holy Spirit in Battle Ground, Washington and Church of the Good Shepherd in Vancouver, Washington, I remember fondly how I felt valued as one member of Christ's body.

That is our hope for the Confirm Not Conform program at St. James's—not that we'll turn out identically perfect Episcopalians, but that every child of God will know that they are valued, and that they will have meaningful experiences with the church.

If our liturgy and theology and history don't help us love and value one another, then all of those aspects of our tradition are irrelevant and not worth passing onto the emerging generation of young people, whom we are privileged to have in our midst.

Your brother in Christ,

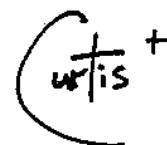

St. James's Center for Children

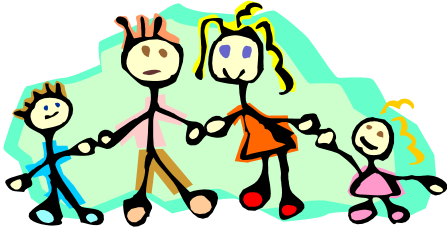

*nurturing your children's spiritual life
from birth through high school*

I AM so excited about how our new program year has begun at St. James's. We have had a great September and October with a lot of amazing activities around this place.

The elementary school Sunday school began with a unit on Joseph from the book of Genesis. This is a rich and deep story to explore with children. All children understand the feelings that Joseph's brothers feel and can learn a lot about forgiveness from Joseph himself. It also delves into the idea that God uses bad things for something good. A special thanks to Virginia Kramer, Lesley Toutain, Marilyn Tomlinson, and Elizabeth Waterman for working with these children in September and October. You all did an amazing job. If you are interested in leading the elementary school children this year in a Sunday school unit, ask one of these wonderful women. They will tell you all about it. In November, we will be exploring what it means to be good stewards of all that God has given us, including the earth, our time, talent and treasure. I am hoping we can tie it all in with stewardship for the adults.

In the preschool room, we had a complete makeover in September. The children are enjoying a beautiful new Sunday school classroom led by Abigail Fisher, Carolyn O'Sullivan, and Kristen Kirsch. I can't wait to see what these ladies can accomplish in their newly renovated space.

In middle school we have been watching the film, *Patch Adams* with the late Robin Williams. This is a wonderful film about the healing power of laughter and genuine nurturing. I am enjoying my time spent with these young people.

In my opinion, one of the most innovative and exciting events that happened this fall, the high school members of the church came up with all on their own. Joe Duva, a junior in high school, active member of the youth group and member of his school's rowing crew, had a Sunday morning regatta. When his fellow youth group members discovered this, they decided to go after church as a group to cheer him on. This, to me, is exactly what we should be doing as a church. We should be out and about, supporting each other in all areas of our lives. I love that these young people decided to do this together and that they had so much fun together supporting Joe. Thanks to all the drivers and chaperones and to Curtis for making it all happen.

Some more activities for young people at St. James's that happened in October include the return of Rhythms of Grace, a liturgical experience for children with special needs. As I said at the beginning of this article, there is a lot going on around here.

So, as I always say, keep the children of this parish in your prayers. If you are able to help out by leading a Sunday school unit let me know. It is lots of fun and a very easy and rewarding way to get involved here at St. James's!

Your sister in Christ,

A handwritten signature in cursive script that reads "Priscilla".

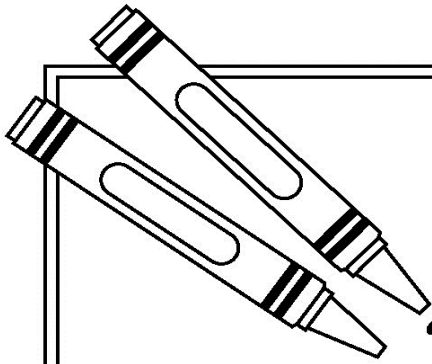

Just for **KIDS**

"Thank You, God"

Thanksgiving is a time to be thankful for all the good things in our lives. God is pleased when we are thankful because He knows that we remember the wonderful things He does for us every day.

Directions: Use the picture clues below to figure out the verse about being thankful. The minus (-) sign means take out the letter(s). The plus sign (+) means to add the letter(s).

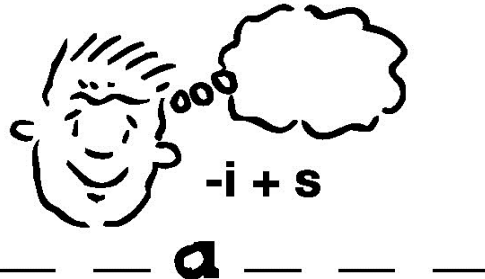
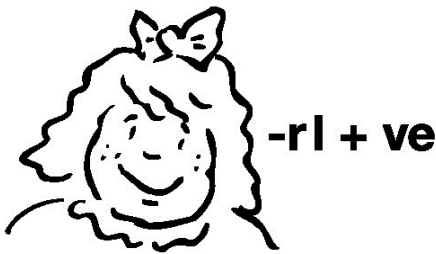

2-w

the

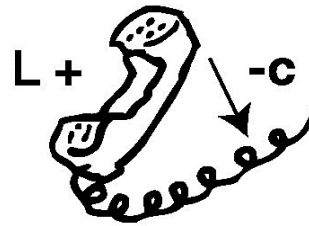

4-u

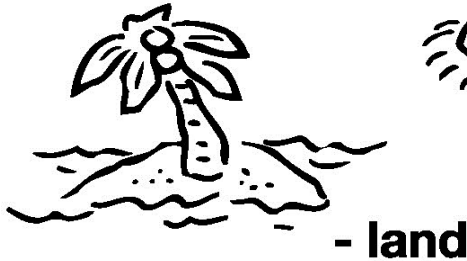
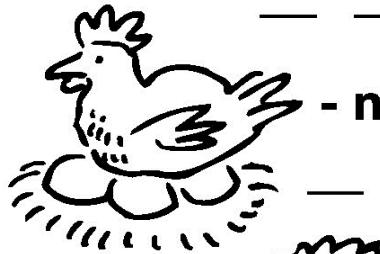

Psalm 107:1

_____ .

Answer: "Give thanks to the LORD for he is good."

From the Organist/Choirmaster

ON October 5, St. James's was treated to a Sunday morning service without our pipe organ. Many of you were curious to know what happened, so I thought I would take this opportunity to answer questions and provide some general information on the current state of our organ.

The organ at St. James's is a giant musical instrument. It contains thousands of pipes, many thousands of moving parts, and was custom designed and built for us in 1962 by the Austin Organ Company of Hartford. We have a unique musical instrument that is 52 years old, with thousands upon thousands of parts. Now consider that this instrument has been used heavily within those decades. These days, a minimum of five musicians play our organ each week for practice, performance, and lessons. Think about it this way: could you imagine sharing a vintage 1962 automobile among five people, week after week? A vehicle that has never been rebuilt?

On October 5, we couldn't use the organ because the mounting system for the blower motor—the engine which turns a large fan to create sufficient wind for the pipes—had reached the end of its life and was placing the fan blades at risk of damage. It was quite amazing that two small pieces of decaying rubber could silence an organ for five days!. Austin Organs came in and replaced the mounting system so our blower motor is now much quieter and no longer in danger of failure. And by the end of October, Austin Organs will have installed a new rectifier—the mechanism which converts alternating current to direct current. The current rectifier is original to the organ and on the brink of failure, so we are preemptively replacing it. If the rectifier failed it would be sudden and disruptive to a Sunday morning.

Until a much larger rebuilding project is initiated, we will do everything we can to keep our organ ready for services. At St. James's, we are so very lucky to have a large pipe organ, wonderful choir, and nice acoustics. We are even luckier to have a parish that supports these unique musical traditions!



Important Dates to Remember

Sunday, November 2
All Saints' Sunday
One Service at 10am
Followed by the Annual
Stewardship Brunch

Wednesday, November 19
**Boys & Girls Choral
Evensong**
IN THE CHURCH AT 6PM
(ALL ARE WELCOME!)

Jubilate Deo!

O be joyful in the
Lord all ye lands;
serve the Lord with
gladness and come
before his presence
with a song.

Psalm 100:1

November Outreach ... Intergenerational Event "Let's Stuff Stockings!"

HELP MAKE a difference at Christmas for the men at two area shelters—our collection of warm socks and toiletries for the men at the Open Hearth and the Salvation Army shelters in Hartford is underway! This outreach project has been in existence since 1989 and is very much appreciated by those who receive these items. Please continue to bring in your donations during the month of November and place them at any of the entrances to the church building. Join us on the First Sunday of Advent, **November 30**, after the 9:30 service to assemble the stockings! These stuffed socks are often the only holiday gift these men receive.

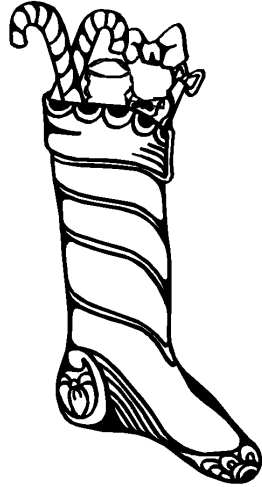

Requested stuffer items are: **sample-size (small)** personal care products such as pocket combs, toothpaste, tooth brushes, deodorant, shaving cream, skin cream, nail files, nail clippers, non-alcoholic mouthwash, shampoo, disposable razors and sample size soaps. We are also collecting **warm, thick men's socks**. We could also use some candy canes to add an additional holiday touch to the socks.

Thank you for supporting this outreach project!

Food Collection ...

PLEASE remember to bring a non-perishable item with you to St. James's each time you come to church! Look for the large, black bins around the building marked "non-perishable foods" or place the items in the wagon located in the cloister. Thank You!

Apple and Pie Sale Results

THE apple and pie sales held recently on Sundays, September 14 and October 5 were a success! A big thank you to all who purchased pies, apples, and other fruit during these sales. We raised a profit of \$337, and these proceeds will greatly benefit the Feeding Programs here at St. James's. Next year the outreach committee plans to offer a fall harvest sale which will include mums, apple cider, apples, pies, and more!

Angel Tree 2014

THIS Advent Season we will continue to support the Angel Tree Project which helps so many families with loved ones who are incarcerated. This program offers a wonderful opportunity to bring the love of Jesus Christ to the children of prisoners during this special season of caring.



The Angel Tree tags with the names of the children and their gift wishes will be available in the Cloister after Sunday services beginning **Sunday, November 30**. Suggested cost of the gifts is \$25. Please bring your wrapped and tagged gifts to the church office by **Sunday, December 14**. Questions or to volunteer, please call Barbara Schiller, at 860-651-7332.

Annual Toy Collection

ONCE again we are collecting toys for children in the Hartford area. Toys, games and fun gifts are needed for children of all ages from toddlers to early teens. These gifts will then be delivered to various churches who will then deliver them to the families in need. Please place your **unwrapped** gifts at any of the three Church entrances by **Sunday, December 7**. Thank you for making Christmas a happier time for these families!

Around the Parish

CHRISTIAN EDUCATION AND FORMATION November 2014

Sunday, November 2

Stewardship Brunch

A St. James's Community Event!

AN opportunity to celebrate and be thankful for the generosity of our community over a tasty brunch after the 10:00 service. Please bring a breakfast item with you to share with the group, if you are able.

Sundays, November 9, 16, 23

Wanton Women and Babylonian Babes: A Discussion of Femininity in the Bible

With Cheri Evans and Margaret Mair in the Parish Room

WE will take a look at recent theories about women of the Old Testament and discuss several lesser-known Biblical women and their stories. Come learn about some of the women we don't often hear about in Church! Come to one session or come to all.

Sundays, November 9, 16, 23

Grass is Green, Buildings are 'Green.' Is Your Faith 'Green?'

With Mark Evans in the Adult Education Room

GLOBAL climate change, water and air pollution, soil degradation, water resource depletion. Do we, as Christians have a responsibility to address these issues? Or, are they someone else's problems. Do we care? As we contemplate our stewardship to the Church, should we also be stewards of God's creation? Come to one session or come to all.

Office Closings

The parish office will be closed for the Thanksgiving Holiday
Thursday & Friday, November 27 & 28

Sunday, November 30

INTERGENERATIONAL EVENT: "Let's Stuff Stockings!"

In the Dining Room

MANY hands are needed to help stuff these holiday stockings for the men at the Salvation and Open Hearth shelters. Refreshment will be served and all are welcome.



The St. James's AUCTION

Tickets on Sale Now!
Cost: \$30 per person

Saturday, November 1 at 7pm

Call the parish office to reserve tickets!
860-521-9620 or info@stjameswh.org

Fall Leaf Clean-Up!

IT'S that time of year again for our annual fall cleanup which will take place on the grounds of St. James's on **Saturday, November 15** beginning at 9:30 until noon. Please bring your rakes, blowers, gloves, and whatever else you think might come in handy. Leaf bags and refreshment will be provided. We need you!



Thanksgiving Day Holy Eucharist



Thursday, November 27
10AM in the Chapel

Let us gather together on this day in celebration and thanksgiving for all of God's many blessings!

All Saints' Sunday—November 2

Holy Eucharist at 10:00 followed by the
Annual Stewardship Brunch in the
Dining Room

*Please bring a breakfast Casserole or
another favorite brunch dish to share with
the group, if you are able.*

First Friday Family Night

COME to First Friday Family Night on
November 7 beginning at 5:30 in the
Dining Room for something different to do
on a Friday evening. Enjoy pizza, a movie, a
craft for the kids, and fellowship with others
from the parish. A \$10 donation is appreciated to
help with the pizza, but not required. Adults may
choose to bring their own beverage.

RSVP to Deb Ross at dross2631@gmail.com to
let her know how many in your family will be
attending.

Rhythms of Grace

Rhythms of Grace -- a
worship and faith
formation experience for
children and families with
special needs will be held on
Sunday, November 9 at 4PM at St. James's
Episcopal Church in West Hartford! Rhythms of
Grace is held every second Sunday of the month
except for July and August.

For more information, please contact Priscilla
Hooper at (860) 521-9620 or go to the website
www.rhythms-of-grace.org to learn more.

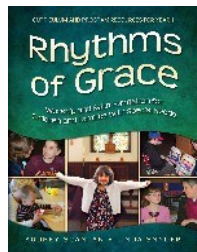

Youth Group Second Sundays

YOUTH (6th-12th grade) are invited to a
behind-the-scenes tour of Bradley
International Airport on **Sunday,
November 9**, but you **MUST** RSVP well in
advance for clearance. Please email Curtis at
fatherfarr@gmail.com.

Parish Birthdays Children & Youth



NOVEMBER

Jack Keough, 1	Eli King, 1
Sam Sadler, 1	Christine Waterman, 1
John Kramer, 2	Milo Vath, 4
Ian Sieklucki, 7	Quinn Ciccone, 9
Abigail Capone, 12	Violet Long, 13
Gabriela Ciccomascolo-Barry, 13	
Bryce Swan, 21	Matthew Gutierrez, 26
Madeline Ross, 26	Sarah Granquist, 29
Nicholas Poulakos, 30	

Parish Registry

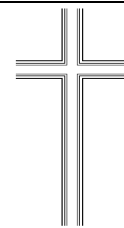

Baptisms

October 19, 2014

Thomas Austin Cox
Son of Charles & Sanders Cox
Aubrey Erin Keough
Daughter of Kenneth & Kelly Keough
Violet Elizabeth Long
Daughter of Joseph & Jennifer Long
George Samuel Nichols III
Son of Nick and Pamela Nichols

Weddings

Hannah DeGiovanni to Bryan Jaeger
October 18, 2014

Deaths

Margaret Wallace
October 15, 2014

Transfers In

The Cox Family
**Charles, Sanders,
Frances, Charles,
and Thomas**

Women's Evening Group

ALL women of the parish and their guests
are invited to an evening of relaxation,
wine, and good food on **Thursday,
November 13 at 6PM** in the Parish Room.
Please bring an appetizer, main dish or casserole,
vegetable, or a dessert to share with the group.
Questions or to RSVP, please contact Sue Nelson
at 860-232-8157. Invite a friend!

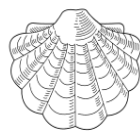

Sunday Lectionary

All Saints' Sunday, November 2

Joshua 3:7-17; Psalm 107:1-7, 33-37
1 Thessalonians 2:9-13; Matthew 23:1-12

22nd Sunday after Pentecost, November 9

Joshua 24:1-3a, 14-25; Psalm 78:1-7
1 Thessalonians 4:13-18; Matthew 25:1-13

23rd Sunday after Pentecost, November 16

Judges 4:1-7; Psalm 123
1 Thessalonians 5:1-11; Matthew 25:14-30

Christ the King Sunday, November 23

Ezekiel 34:11-16, 20-24; Psalm 100
Ephesians 1:15-23; Matthew 25:31-46

First Sunday of Advent, November 30

Isaiah 64:1-9; Psalm 80:1-7, 16-18
1 Corinthians 1:3-9; Mark 13:24-37



Parish Prayer List

Those in our parish family

Jeffrey, Greg, Justin, Joan, Ann, Michael, Michelle, Audrey, Claire, Nicole, Margaret, Ruth, Mae, Ruth, Anne, Donna, Julia, Brian, Sue, Natalie & Harry, John, and Stuart.

Those in our extended parish family

Maria, Pam, Kevin, Mary Ann, Jenifer, Nancy, Jeff, Ashley, Carol, John, Margaret, Katherine, Christina, Jean, Jeff, Roger, Jean, Mario, Jennifer, Leslie, John, Justin, Karen, Bea & David, Heather, Liz, Bryan, Robert, Sarah, Corey, Claudia, David, Carol, Christine, Patricia, Bob, Jessie, Ryan, Lizzy & Taylor, Richard, Dick, Alice & Vito, Linda, John, Quinn, Arroll, Chris, Joanie, Rob, Teresa, Dave, Alvin, Betsy, Karen, Bob, Audra, Parker & Cynthia, Mary, Jackie, Tom, Ted, Olivia, Brent, Kaitlyn, Ann, Kara, Anna, Henry & Irene, Jinah, and Patricia.

Those Serving in the Military

Andrew Clark, Michael P. Clarke,
Eric James Burgess, Mark Ulrich, Ed Vera,

November 2014 Programs and Events

Tuesday, November 4

Business Meeting

Please bring a sandwich

Thursday, November 6

United Thank Offering

Tuesday, November 11

Sarah St. Germain

Coordinator of Public Programs

The Noah Webster House and

West Hartford Historical Society

*Beyond the Grave: Stories of
West Hartford's Past*

Tuesday, November 18

Diana Goode, Executive Director

Gifts of Love

Tuesday, November 25

No Meeting—Thanksgiving

United Thank Offering

Fall Ingathering

Sunday, November 23



THE United Thank Offering is a ministry of the Episcopal Church. Every coin from every Blue Box and Blue Envelope is given away in grants. Every cent you give, representing your thankful prayers today, is the dream for tomorrow's life and gives hope to people all over the world.

This fall we will have our ingathering on **Sunday, November 23 at the 9:30 service.**

Please make checks payable to the Women of St. James's with UTO in the memo line.

Thank You!

WE wish to thank all who helped with this year's fall rummage sale! Thank you for the many items that were donated this year—you really stepped up in the final hours! We could never do it without all of you and because of you, the sale was a success!

The Clergy

The Reverend Robert C. Hooper, III
The Reverend Curtis A. Farr
The Reverend Canon Douglas T. Cooke
The Reverend Dr. Molly O. Louden
The Reverend Dr. Borden W. Painter, Jr.
The Reverend Elsa P. Walberg
The Reverend Terry M. Wysong

Rector
Assistant Rector
Priest Associate
Priest Associate
Priest Associate
Priest Associate
Priest Associate

The Staff

Heidi Cotter, Financial Secretary
 Priscilla Hooper, Director of Religious Education
 Vaughn Mauren, Organist & Choirmaster

Cheryl C. Batter, Administrator
 Randall Martini, Sexton

The Vestry

Ann Cooke, Senior Warden
 David Dynowski, Junior Warden
 Ollie Bunch, Clerk

Michael Sherrill, Treasurer
 Richard M. Wenner, Assistant Treasurer
 David Thomas, Facilities Manager

Term Ending 2015

Doug Compton
 Ron Coons
 Ellen Dollar
 Chuck Willson

Term Ending 2016

Michael Fitzsousa
 Carol McDermott
 Eleanor Michael
 Peter Peterson

Term Ending 2017

Kathy Bolt
 Ben Parish
 Michael Shuey
 Judith Stahl

Committees and Organizations

Acolytes:	Ted Newton	Fundraising:	David Dynowski & Sam Paul
Altar Guild:	Cheri Evans, Sue Nelson	Outreach:	Barbara Schiller
Arbor Society/ Planned Giving:	Ted Newton	Parish Life:	
Choir Guild:	Sam Dynowski	Property Committee:	Rachael Desmond David Thomas
Adult Education:	Mark Evans	Readers & Chalice Bearers:	
Education for Ministry:	Ronald Ward	Sound Committee:	Chuck Russo
Endowment & Investments:	Ted Newton	Ushers:	Derrick Kirsch
Finance:	Harry Meyer	The Women of St. James's:	Edwina Bosco

www.stjameswh.org

email: info@stjameswh.org

860-521-9620

Address Service Requested

www.stjameswh.org

860-521-9620

West Hartford, CT 06107

19 Walden Street

St. James's Episcopal Church

NON-PROFIT ORG.
 U.S. POSTAGE
PAID
 Permit No. 3071
 Hartford, CT